

Mobile 2 RPW USA

User Manual

Operation & Installation Instructions for Mobile 2 RPW USA (Radial Pressure Wave)
REF 2905-US

Rx only



Contents

1. General Information	3
1.1 Introduction	3
1.1.1 Indications	4
1.1.2 Contraindications	4
1.1.3 Warnings and precautions	4
1.2 Symbols	5
1.3 Prerequisites for operating the device	6
1.3.1 Operator	6
1.3.2 Training of the operator	6
1.4 Description of controls and functional elements	7
1.4.1 The device	7
1.4.2 Compressed air supply	8
2. Installation Instructions	9
2.1 Unpacking	9
2.2 Scope of supply	9
2.3 Installation	10
2.3.1 Handpiece holder installation	10
2.3.2 Connecting power supply cables	11
2.3.3 Handpiece connection	12
2.3.4 Potential equalisation (optional)	12
3. Operation	13
3.1 General warnings and safety information	13
3.2 Start-up	14
3.3 Functional checks	16
3.4 Standard settings	16
3.5 Treatment	17
3.6 Info menu	18
3.7 Resetting the handpiece shock counter	18
4. Cleaning, Maintenance, Overhaul	19
4.1 Cleaning the instrument	19
4.2 Device mains fuse replacement	19
4.3 Filter replacement	20
4.4 Maintenance	23
4.5 Disposal	23
4.6 Repair	23
4.7 Service life	23
5. Error Messages and Trouble-shooting	24
5.1 Warnings	24
5.2 Trouble-shooting	25
6. Accessories and Spare Parts	25

7. Technical Specifications of the Control Device	26
7.1 Device	26
7.2 Type plate	26
7.3 Conformity with directives	27
7.4 Conformity with standards	27
8. R-SW handpiece Specifications and Operation	32
8.1 Introduction	32
8.2 Installing and Replacing the transmitter	33
8.3 Cleaning of the handpiece	35
8.4 Cleaning the transmitters	37
8.5 R-SW handpiece overhaul	38
8.5.1 Contents of the R-SW overhaul kit	38
8.5.2 Overhauling the handpiece	39
8.6 Maintenance	42
8.7 Disposal	42
8.8 Repair	42
8.9 Service life	42
8.10 Trouble -shooting	43
8.11 Accessories and Spare Parts	43
8.12 Applicator Specifications	44
9. V-ACTOR II Specifications and Operation	45
9.1 Scope of supply	46
9.2 Unpacking	46
9.3 Connecting the handpiece	46
9.4 Replacing the transmitter	47
9.5 General warnings and safety information	48
9.6 Setting the V-ACTOR ii treatment parameters	48
9.7 Start-up	49
9.8 Functional checks	49
9.9 Standard settings	49
9.10 Treatment	49
9.11 Cleaning	50
9.12 Disposal	51
9.13 Repair	51
9.14 Service life	51
9.15 Trouble-shooting	52
9.16. Accessories and Spare Parts	52
9.17 Technical Specifications	53
10. Warranty and Service	54
10.1 Warranty	54
10.2 Warranty for the handpiece	55
10.3 Service	55

1. General Information

1.1 INTRODUCTION

This manual contains warnings, safety instructions and specific operating instructions in accordance with liability regulations.



DANGER

Refers to a situation of acute danger which, if not avoided, could lead to serious or fatal injury.



WARNING

Refers to a situation of potential danger which, if not avoided, could lead to serious or fatal injury.



CAUTION

Refers to a situation of potential danger which, if not avoided, could lead to minor injury.

ATTENTION

Warns against possibly harmful situations that could lead to damage to either the product or to the surrounding area.

NOTE

Additional information concerning specific features or operating instructions is preceded by the term "NOTE".



CAUTION

Before you start using the device for the first time, please make sure you have read and understood all information provided in this operating manual.



Familiarity with the information and instructions contained in this manual is essential for ensuring efficient and optimal use of the instrument, for avoiding hazards to personnel and equipment and for obtaining good treatment results.

Thorough knowledge of the information included in this manual will also enable you to react promptly and effectively in the event of malfunctions and errors.

When using optional accessories, please also refer to the separate operating manuals for each of these accessories. It is imperative that users be familiar with the content of this manual before operating any part of this system.

The device is a compressed air-operated ballistic shock wave generator. The shock waves in the device are generated with a precision ballistic mechanism in the handpiece. A projectile is accelerated by compressed air. The motion and weight of the projectile produce kinetic energy. When the projectile impacts against an immovable surface, the shock transmitter, this kinetic energy is converted into sound energy. This acoustic pulse is transmitted into the tissue to be treated directly with the help of a gel. These waves are physically classified as radial pressure waves. The applied pressure pulse propagates radially within the tissue and has a therapeutic effect on areas of the tissue near the surface, in particular.

NOTE

Medical devices operating on the basis of the above principle are generally referred to as radial shock wave systems in modern medical literature.



CAUTION

Rx only :

Federal law restricts this device to sale by or on the order of a practitioner licensed by the law of the State in which he/she practises to use or order the use of the device.

1. General Information

1.1.1 INDICATIONS

The device is a compact radial shock wave therapy system. Indications include:

- to relieve minor muscle aches and pains.
- temporary increase in local blood circulation.
- activation of connective tissue.

NOTE

For the activation of connective tissue pressure not higher than 3bar and only D-ACTOR transmitters with a diameter of 20mm and more shall be used.

1.1.2 CONTRAINDICATIONS



CAUTION

The precautions listed here are examples.

No claims are made regarding the completeness or unlimited validity of this list of precautions.

Treatment with the device is not permitted in the following cases:

- malignant tumor in the treatment area
- fetus in the treatment area



CAUTION

This device should not be used over swollen or inflamed areas or skin eruptions.

Do not use in presence of unexplained calf pain.

There is a potential for discomfort when using the device on bony surfaces.

Be aware of the potential for bruising and hematoma!

Never use this device on children, the unconscious, or anyone who cannot give verbal consent or warnings about pain.













1.1.3 WARNINGS AND PRECAUTIONS

- Do not use in the presence of unexplained pain.
- If a patient reports significant or unexpected pain, immediately stop the treatment and consult a physician.
- Do not apply pulses to any regions near large nerves, vessels, the spinal column or head.
- ALWAYS move the handpiece over the treatment area. Continuous repetitive pulses concentrated in one spot may lead to bruising.
- Use of this device may be painful or cause bruising. NEVER use this device on children, the unconscious, or anyone who cannot give verbal consent or warnings about pain.
- This device should not be used over swollen or inflamed areas or skin eruptions.
- Do not treat wounds, infected areas, skin tumors, open sores, or scars from recent surgery.
- Caution should be used over joints or bony prominence such as vertebrae.

1. General Information

1.2 SYMBOLS

The markings on the Mobile 2 RPW USA system are your assurance of its conformity to the highest applicable standards of medical equipment safety and electromagnetic compatibility. One or more of the following markings may appear on the device:

	Type B Applied part
	Potential equalisation
	R-SW / V-ACTOR handpiece connection
	Council Directive 2012/19/EU concerning Waste Electrical and Electronic Equipment (WEEE). Indicates a requirement not to dispose of WEEE as municipal waste. Contact your local distributor for information regarding disposal of the unit and accessories.
	Wear hearing protection!
	USB connection
 2 0 x x	Name and address of the manufacturer and manufacturing date.
	Complies with the Medical Device Directive 93/42/EEC
	CSA certification mark
	Refer to Instruction Manual/Booklet
	Fuse
	Electromagnetic interference may occur in the vicinity of instruments marked with this symbol.
	Hot surface

1. General Information

	Explosion
---	-----------

1.3 PREREQUISITES FOR OPERATING THE DEVICE

1.3.1 OPERATOR

The device is intended exclusively for use by medical specialists and may only be used by qualified and instructed medical persons. Such a specialist is expected to have practical knowledge of medical procedures and applications as well as of the terminology, and should be experienced in treating the indications stated in chapter 1.1.1.

The specialist must have the basic physical and cognitive prerequisites such as vision, hearing and reading. Furthermore, the basic functions of the upper extremities must be guaranteed. The instrument is designed for a demographic target group between 18 and 65 years.

1.3.2 TRAINING OF THE OPERATOR

Operators of the device must have been adequately trained in using this system safely and efficiently before they operate the instrument described in this handbook. An introduction to the principles of operation will be provided by your dealer with reference to this operating manual and will be documented in the system logbook.

The operator must be instructed in the following points:

- Instruction in operation and designated use of the instrument with practical exercises
- Mechanism of action and function of the instrument and the energies delivered by it
- All component settings
- Indications for use of the instrument
- Contraindications and side effects of the therapy waves
- Explanation of the warning notes in all operating statuses
- Instruction in how to perform the functional checks

Further training requirements vary from country to country. It is the operator's responsibility to ensure that the training meets the requirements of all applicable local laws and regulations. Further information on training in the operation of this system is available from your dealer. However, you can also contact the following address directly:

DJO, LLC
1430 DECISION STREET
VISTA, CA 92081
USA
T: +1 800 494 3395
E: CHATTPRODUCTSUPPORT@DJOGLOBAL.COM

1. General Information

1.4 DESCRIPTION OF CONTROLS AND FUNCTIONAL ELEMENTS

1.4.1 THE DEVICE



Fig. 1 - 1 Front view of the device

- 1 Display of selected shock frequency
- 2 Treatment shock counter
- 3 Display of selected pressure (nominal value)
- 4 Shock counter reset button
- 5 Dial for setting the pressure
- 6 Handpiece
- 7 Handpiece connector
- 8 Buttons for setting the shock frequency

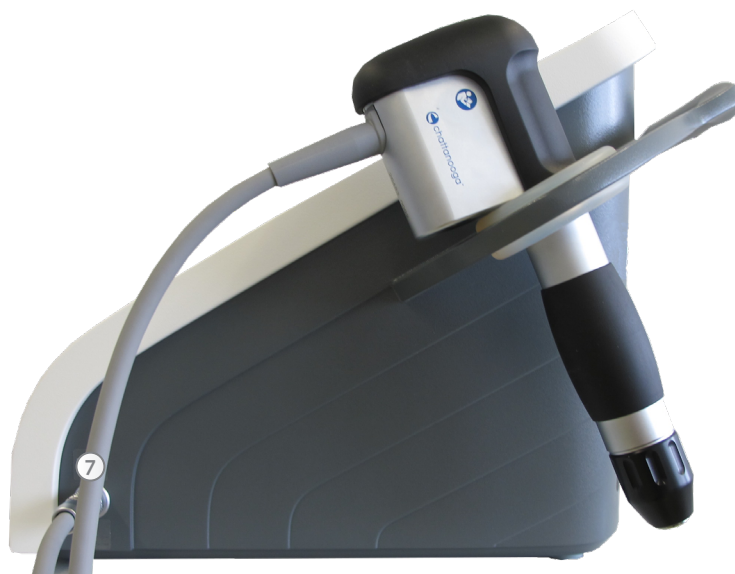

Fig. 1 - 2 Side view of the device

1. General Information



Fig. 1 - 3 Rear view of the device

- 1 Type plate
- 2 USB connection
- 3 Filter housing
- 4 Mains connection
- 5 Potential equalisation connection
- 6 Mains fuse holder
- 7 Mains switch

NOTE

The USB connection (Fig. 1-3) is only suitable for connecting a USB memory stick which supports the USB V1.1 protocol.



Fig. 1 - 4 Back cover of the device

1.4.2 COMPRESSED AIR SUPPLY

The compressed air is supplied by an integrated compressor.

2. Installation Instructions

2.1 UNPACKING

- Carefully remove the instrument and accessories from the packaging container.
- Check that all items are included in the packaging container and that they are not damaged.
- Contact your supplier or the manufacturer immediately if any items are missing or damaged. Retain the original packaging. It may prove useful for any later equipment transport.

2.2 SCOPE OF SUPPLY

The standard scope of supply of the Mobile 2 RPW USA includes the following items:

- Control device
- R-SW handpiece
- Mains cables
- Gel bottle
- User manual
- Service set
- 2 Transmitters

Please refer to chapter 6 ACCESSORIES AND SPARE PARTS for information on optional accessories.

2. Installation Instructions

2.3 INSTALLATION

2.3.1 HANDPIECE HOLDER INSTALLATION

- The handpiece can be placed on the right or on the left side of the system.



Fig. 2 - 1 Position of the handpiece holder



Fig. 2 - 2 Position of the handpiece holder

2. Installation Instructions

2.3.2 CONNECTING POWER SUPPLY CABLES

- Connect the supplied mains cable to the mains connection (Fig. 2 - 3/1) on the rear of the instrument.



Fig. 2 - 3 Connecting power supply cables

- Insert the mains plug into the socket.

ATTENTION

When setting up the instrument, make sure that the air outlets on the housing of the device are not blocked.
The instrument must only be connected to properly earthed and correctly installed shockproof sockets!

2. Installation Instructions

2.3.3 HANDPIECE CONNECTION

- Connect the plug of the handpiece to the handpiece connection (Fig. 2 - 4/1) on the device.

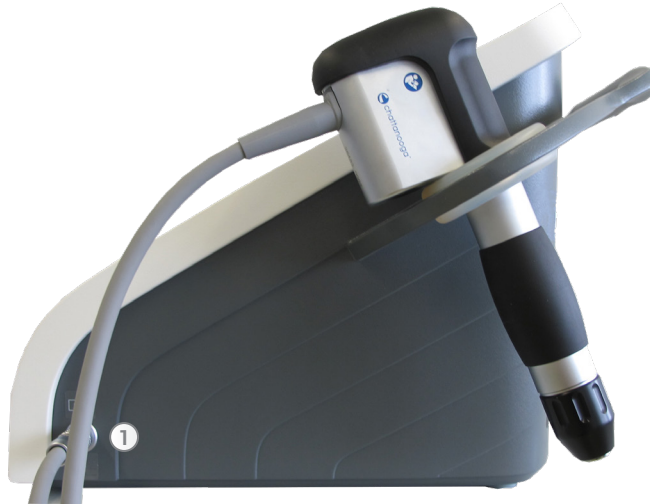

Fig. 2 - 4 Handpiece connection

- Make sure that the red dots on the connector match the red dots on the handpiece connection (Fig. 2 - 5).



Fig. 2 - 5 Connecting the handpiece

- Place the handpiece into the handpiece holder.

2.3.4 POTENTIAL EQUALISATION (OPTIONAL)

The device features a potential equalisation connection (Fig. 1 - 3/5). Where necessary, connections for potential equalisation must be made by suitably qualified personnel.



CAUTION

The potential equalization connection must be connected in accordance with the relevant national regulations.

3. Operation

3.1 GENERAL WARNINGS AND SAFETY INFORMATION



CAUTION

The device is intended exclusively for use by medical specialists and may only be used by such suitably qualified and trained medical personnel (see chapter 1.3 PREREQUISITES FOR OPERATING THE DEVICE).

The user is responsible for correctly positioning the handpieces of the device.

Correct determination of the location of the treatment zone is the responsibility of the user.

Only perform treatments approved by the manufacturer!

To avoid safety hazards, use of the instrument for applications other than those specified in chapter 1.1.1 INDICATIONS is not allowed!

The device has a potential equalisation connection. This must be connected in accordance with the relevant national regulations.

Do not use the device in potentially explosive environments, i.e. in the presence of a flammable anaesthetic mixture with air or with oxygen or nitrous oxide.

If instruments are connected that are not medical products as defined by EN IEC 60601, they must be set up outside the vicinity of the patient.

Cleaning agents and disinfectants can form an explosive atmosphere. Disconnect the device from the mains before starting any cleaning or maintenance work!

Before any cleaning and maintenance work on the handpiece, disconnect the handpiece plug from the handpiece connection! Do not connect the handpiece until it has been completely reassembled!



CAUTION

Do not try to open the instrument! Risk of electric shocks!

Risk of transmission of microorganisms! Disinfect the handpiece after each treatment!

Also refer to chapter 4 CLEANING, MAINTENANCE, OVERHAUL for details.

ATTENTION

Check that the installation surfaces have sufficient carrying capacity to avoid equipment damage!

Portable and mobile HF communications equipment (e.g. mobile phones) can interfere with electrical equipment.

The use of accessories or cabling not authorised by the manufacturer may cause increased emissions or may lead to reduced interference resistance of the device.

The device must neither be deployed nor stored together with other devices. If the operation near or jointly with other devices is required, the device must be tested in that particular environment to ensure operation according to technical specification. The device may be positioned and operated near the listed accessories.

The instrument must only be connected to properly earthed and correctly installed shockproof sockets!

Check that the instrument is in perfect working order before each use (see chapter 3.3 FUNCTIONAL CHECKS).

Never cover the instruments when in use!

Make absolutely sure that no liquid can seep into the system housing or handpiece.

Any damage to the instrument resulting from incorrect operation is not covered by the manufacturer's warranty.

Disposal of the instrument and its components must be carried out in accordance with national waste disposal regulations.

The device must only be used with accessories that have been approved by the system manufacturer. To prevent safety hazards, unauthorized system modifications are not allowed. This will void the CE mark approval and warranty.

3. Operation

NOTE

The device meets the requirements of the applicable electromagnetic compatibility (EMC) standards EN 60601-1-2. These requirements are designed to provide reasonable protection against harmful interference in a typical medical installation. The instrument described here generates and uses high-frequency energy and can emit the same. If not installed and used in accordance with these instructions, the instrument may cause harmful interference with other devices in the vicinity. However, there is no guarantee that interference will not occur in a particular installation. If this product does cause harmful interference with other devices, which can be determined by turning the instrument off and on, the user is encouraged to try to correct the interference by one or more of the following measures:

- Reorient or relocate the receiving device.
- Increase the distance between the devices.
- Connect the devices to an outlet on a circuit different from that to which the other device is connected.
- Consult the manufacturer or field service technician for help.

3.2 START-UP

NOTE

Prior to start-up, please refer to chapter 8 and 9 for your handpiece.

- Switch on the device at the mains switch on the back of the instrument (Fig. 1 - 3/7).

Once the unit has been started, the display automatically shows the last shock frequency setting. The display flashes.

- To confirm the existing setting, press one of the two arrow keys.
- To change the existing setting, press one of the two arrow keys. As soon as the display has stopped flashing, the selected shock frequency can be increased or reduced using the arrow keys.

With the device, the shock wave frequency can be selected in steps.

Operating Mode	Energy/Frequency
R-SW	1.0 - 4.0 bar / max. 21 Hz
R-SW	4.6 bar / max. 15 Hz
R-SW	5.0 bar / max. 12 Hz
V-ACTOR	1.4 - 3.0 bar / max. 31 Hz
V-ACTOR	3.8 bar / max. 22 Hz
V-ACTOR	5.0 bar / max. 13 Hz

- Set the energy of the shocks to an initial value of 1.5 bar using the dial (Fig. 3 - 1/5). The value is displayed on the pressure display (Fig. 3 - 1/3).

3. Operation



Fig. 3 - 1 Setting the energy on the control device

- 1 Display of selected shock frequency
- 2 Treatment shock counter
- 3 Display of selected pressure (nominal value)
- 4 Shock counter reset button
- 5 Dial for setting the pressure
- 6 Handpiece
- 7 Handpiece connector
- 8 Buttons for setting the shock frequency

The maximum application pressure is limited to 5 bar. To ensure correct system operation, a minimum pressure of 1.0 bar is required.

- Press the trigger button on the handpiece.
- To work in single shock mode, select the “-” symbol (dash) in the “Frequency” selection box and activate the trigger button.
- To work in continuous shock mode, select a continuous shock frequency in the range from:

Operating Mode	Energy/Frequency
R-SW	1.0 - 4.0 bar / max. 21 Hz
R-SW	4.6 bar / max. 15 Hz
R-SW	5.0 bar / max. 12 Hz
V-ACTOR	1.4 - 3.0 bar / max. 31 Hz
V-ACTOR	3.8 bar / max. 22 Hz
V-ACTOR	5.0 bar / max. 13 Hz

- Activate the trigger button.

NOTE

A pressure change automatically entails a change in frequency if the set frequency exceeds the maximum permitted frequency (see Table 3 - 1)

3. Operation

3.3 FUNCTIONAL CHECKS

Perform the following functional checks after the instrument has been installed:

- Check the control device and handpiece for damage.
- Put the device into operation.
- Set the pressure to 1.6 bar.
- Reset the treatment shock counter (Fig. 3 - 1/2) with the reset button (Fig. 3 - 1/4) on the front of the instrument.
- Release individual shocks in single shock mode.
- Release shocks in continuous shock mode (shock frequency 1 Hz and 15 Hz).
- Check that the triggered shocks are correctly counted on the treatment shock counter on the front of the instrument.
- Set the pressure to maximum 5 bar.
- Release individual shocks in single shock mode.
- Release shocks in continuous shock mode (shock frequency 1 Hz and 8 Hz).
- Test the other frequencies as follows:

Operating Mode	Energy/Frequency
R-SW	4.0 bar / max. 21 Hz
R-SW	4.6 bar / max. 15 Hz
R-SW	5.0 bar / max. 12 Hz
V-ACTOR	3.0 bar / max. 31 Hz
V-ACTOR	3.8 bar / max. 22 Hz
V-ACTOR	5.0 bar / max. 13 Hz

3.4 STANDARD SETTINGS

- Before each treatment, set the treatment shock counter (Fig. 3 - 1/2) on the control device to zero by pressing the reset button (Fig. 3 - 1/4).
- A total of about 2,000 shocks must generally be applied per therapy session. Please refer to the device application brochure for details.
- Start the treatment at a pressure of 1 bar and a frequency of 5 Hz.

3. Operation

3.5 TREATMENT



CAUTION

The transport bag is provided only to transport the device. If the device is left in the transport bag during treatment, the device becomes hot, due to lack of ventilation. Burns, conflagration and damages of the device are possible.

- Take the device out of the transport bag during treatment.



CAUTION

Read chapter 3.1 GENERAL WARNINGS AND SAFETY INFORMATION before beginning treatment.

Please also follow the instructions in chapter 8 and 9 for your handpiece.

Each time after the instrument has been transported, make sure that all functional checks have been performed on the instrument before you start treatment.

Only perform treatments approved by the manufacturer!

To avoid safety hazards, use of the instrument for applications other than those specified in chapter 1.1.1 INDICATIONS is not allowed!

All status and error messages signaled during treatment must always be attended to without delay!

The maximum energy level used during treatment must not cause the patient undue pain under any circumstances.



CAUTION

We recommend that the user and the patient wear suitable hearing protection.

- Always offer the patient hearing protection.

- Apply a sufficient amount of coupling gel to the patient's skin in the treatment area and to the shock transmitter.

- Do not apply more than 300 shocks to the same spot during treatment.

- Avoid excessive pressure of the shock transmitter to the patient's skin. Excessive pressure is not necessary for the success of the treatment.



CAUTION

The shock transmitter surface temperature can reach up to 47°C. Extended skin contact can lead to minor burns!

- Interrupt treatment after a maximum of 6,000 pulses.



CAUTION

The handpiece may not be operated while idling (without an impact surface).

- Do not trigger pulses unless the pulse transmitter is in contact with the treatment zone!

3. Operation

3.6 INFO MENU

The Info menu enables you to reset the handpiece counter, to call up the total shock count and instrument operating hours as well as to read out data on monitoring software, hardware serial numbers and modification status.

- To activate the Info menu, press both arrow keys simultaneously and hold them for two seconds.

The display changes to Info mode: The top line (nominal energy display) shows the menu item in question as a number between 1 and 10. (Fig. 3 - 2/1), whereas the middle line (Fig. 3 - 2/2) shows the called-up information (in this case: hardware article no.).

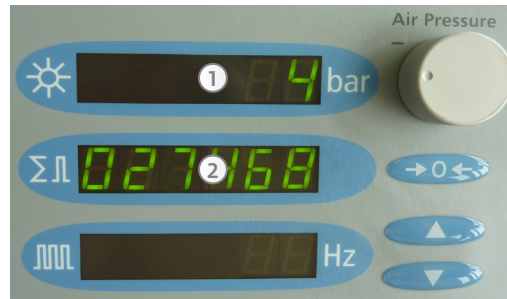

Fig. 3 - 2 Info mode

- Use the dial to move up or down in the menu in order to call up the following data:

Menu Item	Display
1	Handpiece pulse counter
2	Total pulse counter
3	Operating hours counter
4	Hardware article no.
5	Hardware change index
6	Not used
7	Software article no.
8	Software change index
9	Boot loader article no.
10	Not used

NOTE

Shock counter displays 1 and 2 display the shock count in steps of one thousand.

- To exit the Info menu, press both arrow keys simultaneously and hold them for two seconds.

3.7 RESETTING THE HANDPIECE SHOCK COUNTER

- Switch to Info mode (see chapter 3.6 INFO MENU).
- Select menu item 1 - Handpiece counter.

The number of shocks is displayed in steps of one thousand. The value displayed in the middle line multiplied by 1,000 gives the counter reading for the current handpiece.

- Press the reset button to set the handpiece counter to zero.

4. Cleaning, Maintenance, Overhaul



CAUTION

Disconnect the instrument from the mains before starting any cleaning or overhaul work!

4.1 CLEANING THE INSTRUMENT

- Wipe the exterior of the housing with a damp cloth. Use soapy water or a mild cleaning agent.

ATTENTION

It is essential that no fluid be permitted to penetrate either the instrument or its tubing.

4.2 DEVICE MAINS FUSE REPLACEMENT

The mains fuse holder is located on the rear panel of the device.

- Push the clip of the mains fuse holder (Fig. 4 - 1/1) to the left and take the holder off the housing.



Fig. 4 - 1 Mains fuse holder

- Pull the old fuses out of the mains fuse holder (Fig. 4 - 2).



Fig. 4 - 2 Fuse replacement

- Replace the fuses.
- Use type T4AL/250 VAC fuses.
- Push the mains fuse holder back into the opening until it engages.

4. Cleaning, Maintenance, Overhaul

4.3 FILTER REPLACEMENT

The filter element of the compressor should be replaced in case of compressor performance loss (marked drops in pressure during the release of shock waves or pressure pulses). Proceed as follows:

- Switch off the instrument at the mains switch on the rear panel, and disconnect the mains power link cable from the connection on the compressor.
- Remove the condensate collector from the holder and empty it.
- Remove the pressure filter housing. It can be unscrewed by hand.



Fig. 4 - 3 Unscrewing the pressure filter housing



Fig. 4 - 4 Pressure filter housing removed

4. Cleaning, Maintenance, Overhaul

- Remove the filter element holder from the pressure filter housing.
- Ensure that both O-rings (Fig. 4-5/1 and Fig. 4-5/2) do not slip and are not misplaced.



Fig. 4 - 5 Filter element holder removed

- Disassemble the filter element holder.



Fig. 4 - 5 Filter element holder disassembled

- Remove the bottom of the filter element holder.



Fig. 4 - 6 Bottom of filter element holder removed

4. Cleaning, Maintenance, Overhaul

- Remove the top of the filter element holder.

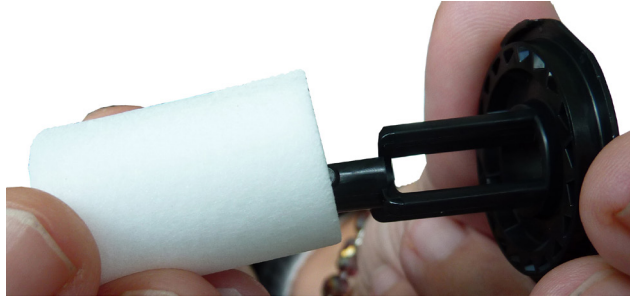

Fig. 4 - 8 Top of filter element holder removed

- Remove the new filter element from its packaging.
- Place the top and bottom of the holder in the new filter element and screw them together.
- Replace the filter element holder with the new filter element in the pressure filter housing.
- When connecting the pressure filter housing with the top of the filter element, ensure that the top of the filter element audibly engages.
- Ensure that both O-rings (Fig. 4-5/1 and Fig. 4-5/2) do not slip and are not misplaced.



Fig. 4 - 9 Inserting the filter element holder into the pressure filter housing

- Screw the pressure filter housing finger-tight into the holder. Ensure that the housing is correctly aligned while screwing it in.



Fig. 4 - 9 Screwing the pressure filter housing in place

- Tighten the condensate collector into the holder.
- Plug in the mains cable.

4. Cleaning, Maintenance, Overhaul

4.4 MAINTENANCE

Preventive maintenance is not necessarily required. However, regular maintenance may help to identify possible defects at an early stage and thus increase the safety and service life of the equipment. Maintenance services can be ordered from our regional representatives in your area.

We recommend that functional and safety checks be performed at least once a year. National accident prevention regulations and test and inspection intervals prescribed for medical devices must, of course, be observed.

NOTE

For further details on content and performance of the safety checks please contact your local dealer.

The following checks should be performed to ensure that the device operates safely.

1. Earth leakage current test in accordance with national regulations.
2. Earth impedance test (incl. handpiece housing and with mains cable) in accordance with national regulations.

4.5 DISPOSAL

When disposing of the present medical products, no special measures have to be observed. Please proceed in accordance with applicable country-specific regulations. After expiration of its service life, dispose the device as waste electronic equipment.

4.6 REPAIR

Repair work on defective instruments must only be carried out by personnel suitably authorised by DJO LLC. Use only original parts designated by STORZ MEDICAL AG and supplied by DJO LLC. The personnel suitably authorised can be from DJO LLC or be representatives of DJO LLC agencies and dealers.

4.7 SERVICE LIFE

The average expected service life (MTTF) in accordance with EN60601-1:2005 + A1:2012 is

- approximately 3 500 hours for the medical - electrical device Chattanooga Mobile 2 RPW USA.

For information about the service life of your handpiece, please refer to section 8.9 (Service life R-SW handpiece) and section 9.14 (Service life V-ACTOR handpiece).

Exceeding the service life can be expected to result in a failure of the instrument and accessories.



















This also applies to handpieces.

No warranty claims shall be accepted beyond the information given in chapter 8.

5. Error Messages and Trouble-shooting

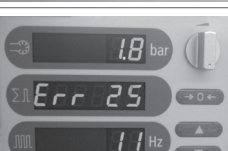
5.1 WARNINGS

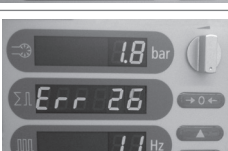
The following list gives the most important error codes and the actions that you should take if they occur.

Error number	Fault description	Corrective action
Error 1 	Memory error	Acknowledge by pressing the reset button,  continued operation is possible.
Error 10 	Trigger button is pressed during start-up	Release the trigger button, continued operation is possible.
Error 11 	The handpiece is not connected	Connect the handpiece, continued operation is possible.
Error 12 	Internal fault	Acknowledge by pressing the reset button,  continued operation is possible.
Error 20 	Internal fault	Acknowledge by pressing the reset button,  continued operation is possible.
Error 21 	Internal fault	Acknowledge by pressing the reset button,  continued operation is possible.
Error 22 	Problem with update on USB stick	Acknowledge by pressing the reset button.  Check update on stick, continued operation is possible.
Error 23 	USB stick not inserted	Insert USB stick
Error 24 	Problem with update on USB stick	Acknowledge by pressing the reset button.  Check update on stick, continued operation is possible.
Error 25 	Problem with update on USB stick	Acknowledge by pressing the reset button.  Check update on stick, continued operation is possible.
Error 26 	No current software update	Acknowledge by pressing the reset button.  Check update on stick, continued operation is possible.

5. Error Messages and Trouble-shooting

5.2 TROUBLE-SHOOTING



CAUTION

Unplug the mains cable from the instrument before you carry out any maintenance work!

Fault description	Possible cause	Corrective action
Instrument does not work	<ul style="list-style-type: none"> • Power failure • Defective mains fuse • Defective mains plug 	<ul style="list-style-type: none"> • Check the power supply • Replace the fuses • Replace the mains cable
No compressed air supply	<ul style="list-style-type: none"> • Leaks in handpiece cable or cable not properly connected • Clogged compressor air filter 	<ul style="list-style-type: none"> • Check the cable and tube connections and replace them, if necessary • Check the compressor air filter and replace it, if necessary
No shock wave power output	<ul style="list-style-type: none"> • No compressed air supply • Blocked or worn projectile • Malfunction in control device • Handpiece defective 	<ul style="list-style-type: none"> • Dismantle the handpiece • Clean the guide tube and projectile • Overhaul the handpiece • Call your Service centre • Replace the handpiece

6. Accessories and Spare Parts

Description	Part Number
R-SW Handpiece Set	32000
R040 15mm ESWT Transmitter	28178
D20-S R-SW 20 mm transmitter	29724
Revision kit	23825
Conductor transmission gel 250 ml (8.5 oz) bottle	22601
CD User Manual	13-00060-US
Carrying bag	28745
V-ACTOR II Handpiece Set	28730

For further accessories see Chapter 8.11 and Chapter 9.16

7. Technical Specifications of the Control Device

7.1 DEVICE

R-SW operating mode	Single shock, continuous shock 1.0 - 4.0 bar / max. 21 Hz 4.6 bar / max. 15 Hz 5.0 bar / max. 12 Hz
V-ACTOR operating mode	1.4 - 3.0 bar / max. 31 Hz 3.8 bar / max. 22 Hz 5.0 bar / max. 13 Hz
Mains input voltage	100 - 240 VAC
Mains frequency	50 - 60 Hz
Mains fuse	T4AL/250 VAC
Power consumption	max. 200 VA
Compressed air output	1 - 5 bar
Ambient temperature during operation	10 - 40 °C
Ambient temperature during storage and transport	0° - 60° C frost-free
Ambient air pressure during operation	800 - 1060 hPa
Ambient air pressure during storage and transport	500 - 1060 hPa
Air humidity	5 - 95%, non-condensing
Control device weight	8.2 kg
Housing dimensions (W x H x D)	490 x 290 x 400 mm
Classification according to MDD	Class IIa device
Protection against the ingress of water	IPX1

Subject to technical modifications

Equipment safety ("essential performance") according to IEC 60601-1, 3rd edition:
ME equipment shall be free from excessive pressure wave energy.

NOTE

When the medical product is distributed to third parties, the following must be observed:

- The complete device documentation must be delivered together with the medical product.
- The medical product may only be exported to a foreign country when the medical product and the corresponding indications are allowed there.

7.2 TYPE PLATE



STORZ MEDICAL AG
Lohstampfstrasse 8
CH - 8274 Tägerwilten

yyyy-mm-dd

T4AL, 250 V

100-240 V~ / 50-60 Hz / 200 VA / IPX1



SN CS.xxxx



(01)GTIN(21)SN(11)PRODDATE

SWISS MADE

Exclusively distributed by:
DJO, LLC

CHATTANOOGA
Mobile 2 RPW USA

Fig. 7 - 1 Type plate

7. Technical Specifications of the Control Device

7.3 CONFORMITY WITH DIRECTIVES

This medical product bears the CE mark in accordance with the Medical Device Directive (MDD) 93/42/EEC.

7.4 CONFORMITY WITH STANDARDS

According to EN 60601-1	
Type of protection against electric shocks:	Protection class 1
Application unit of Type B*	

*Application units include the surfaces of the R-SW and V-ACTOR handpieces, including the interchangeable transmitters.

EMC GUIDELINES AND MANUFACTURER'S DECLARATION

Guidelines and manufacturer's declaration – emitted electromagnetic interference		
The device model is intended for use in the electromagnetic environment specified below. The customer or the user of the device should assure that it is used in such an environment.		
Emitted interference measurements	Compliance	Electromagnetic environment – guidelines
HF emissions according to CISPR 11	Group 1	The device uses HF energy only for its internal functioning. Therefore, its HF emissions are very low and are not likely to cause any interference in nearby electronic equipment. I
HF emissions according to CISPR 11	Class B	The device is suitable for use in all facilities, including those in residential areas and those that are directly connected to a public electricity supply network that also powers devices which are used for residential purposes.
Harmonic emissions according to IEC 61000-3-2	Class A	
Voltage fluctuations / flicker emissions according to IEC 61000-3-3	Complies	

7. Technical Specifications of the Control Device

Guidelines and manufacturer's declaration – Resistance to emitted electromagnetic interference			
The device model is intended for use in the electromagnetic environment specified below. The customer or the user of the device should assure that it is used in such an environment.			
Emissions resistance tests	IEC 60601 test level	Compliance level	Electromagnetic environment – guidelines
Electrostatic discharge (ESD) according to IEC 61000-4-2	±6 kV contact discharge ±8 kV air discharge	±6 kV contact discharge ±8 kV air discharge	Floors should be wood, concrete or ceramic tile. If floors are covered with synthetic material, the relative humidity should be at least 30%.
Electrical fast transient disturbances/bursts according to IEC 61000-4-4	±2 kV for power supply lines ±1 kV for input/output lines	±2 kV for power supply lines ±1 kV for input/output lines	Mains power quality should be that of a typical commercial or hospital environment.
Surges according to IEC 61000-4-5	±1 kV line(s) to line(s) ±2 kV line(s) to earth	±1 kV line(s) to line(s) ±2 kV line(s) to earth	Mains power quality should be that of a typical commercial or hospital environment.
Voltage drops, short interruptions and voltage variations on power supply input lines according to IEC 61000-4-11	< 5% U_T (> 95% drop in U_T) for ½ period 40% U_T (60% drop in U_T) for 5 periods 70% U_T (30% drop in U_T) for 25 periods < 5% U_T (> 95% drop in U_T) for 5 s	< 5% U_T (> 95% drop in U_T) for ½ period 40% U_T (60% drop in U_T) for 5 periods 70% U_T (30% drop in U_T) for 25 periods < 5% U_T (> 95% drop in U_T) for 5 s	Mains power quality should be that of a typical commercial or hospital environment. If the user of the device requires continued operation during power mains interruptions, it is recommended that the device be powered from an uninterruptible power supply.
Power frequency (50/60 Hz)magnetic field according to IEC 61000-4-8	3 A/m	3 A/m	The mains frequency magnetic fields should be those of a typical business or hospital environment.
NOTE: U_T is the mains alternating voltage prior to application of the test level.			

7. Technical Specifications of the Control Device

Guidelines and manufacturer's declaration – Resistance to emitted electromagnetic interference

The device model is intended for use in the electromagnetic environment specified below. The customer or the user of the device should assure that it is used in such an environment.

Emissions resistance tests	IEC 60601 test level	Compliance level	Electromagnetic environment – guidelines
			<p>Portable and mobile RF equipment should be used no closer to any part of the device, including cables, than the recommended safety distance calculated from the equation applicable to the frequency of the transmitter.</p> <p>Recommended safety distance:</p>
Conducted HF interference according to IEC 61000-4-6	3 V _{rms} 150 kHz to 80 MHz	3 V _{rms} 150 kHz to 80 MHz	$d = 1.2\sqrt{P}$
Radiated HF interference according to IEC 61000-4-3	3 V/m 80 MHz to 2.5 GHz	3 V/m 80 MHz to 2.5 GHz	$d = 1.2\sqrt{P}$ for 80 MHz to 800 MHz $d = 2.3\sqrt{P}$ for 800 MHz to 2.5 GHz
			<p>Where P is the rated power of the transmitter in watts (W) according to the transmitter manufacturer and d is the recommended safety distance in metres (m).</p> <p>The field intensity of stationary radio transmitters, based on an on-site inspection ^a, should be less than the compliance level ^b.</p> <p>Interference may occur in the vicinity of instruments marked with the following symbol.</p> 

NOTE 1 At 80 MHz and 800 MHz, the higher frequency range applies.

NOTE 2 These guidelines may not apply in all situations. Electromagnetic propagation is affected by absorption and reflection from structures, objects and people.

a
Field strengths from fixed transmitters, such as base stations for radio (cellular/cordless) telephones and land mobile radios, amateur radio, AM and FM radio broadcast and TV broadcast cannot be predicted theoretically with accuracy. To assess the electromagnetic environment with respect to fixed RF transmitters, an electromagnetic site survey should be considered. If the measured field strength in the location in which the device is used exceeds the applicable HF compliance level indicated above, the device should be observed to verify normal operation. If abnormal performance is observed, additional measures may be necessary, such as re-orienting or relocating the device.

b
Over the frequency range of 150 kHz to 80 MHz, field strengths should be less than 3 V/m.

7. Technical Specifications of the Control Device

Recommended safety distances between portable and mobile HF communications equipment and the device

The device is intended for use in an electromagnetic environment in which radiated HF disturbances are controlled. The customer or the user of the device can help prevent electromagnetic interference by maintaining a minimum distance between portable and mobile HF communications equipment (transmitters) and the device as recommended below, according to the maximum output power of the communications equipment.

Rated power of transmitter [W]	Safety distance according to frequency of transmitter [m]		
	150 kHz to 80 MHz $d = 1.2\sqrt{P}$	80 MHz to 800 MHz $d = 1.2\sqrt{P}$	800 MHz to 2.5 GHz $d = 2.3\sqrt{P}$
0.01	0.12	0.12	0.23
0.1	0.38	0.38	0.73
1	1.2	1.2	2.3
10	3.8	3.8	7.3
100	12	12	23

For transmitters rated at a maximum output power not listed above, the recommended safety distance can be estimated using the equation applicable to the frequency of the transmitter, where P is the rated power of the transmitter in watts [W] according to the transmitter manufacturer.

NOTE 1

An additional factor of 10/3 was used for calculating the recommended safety distance of transmitters in the frequency range from 80 MHz to 2.5 GHz in order to reduce the probability that a mobile/portable communications device brought into the patient area inadvertently might lead to a malfunction.

NOTE 2

These guidelines may not apply in all situations. Electromagnetic propagation is affected by absorption and reflection from structures, objects and people.

7. Technical Specifications of the Control Device

STORZ MEDICAL

**EG-KONFORMITÄTSERKLÄRUNG · EC DECLARATION OF CONFORMITY
DECLARACIÓN CE DE CONFORMIDAD · DICHIARAZIONE CE DI CONFORMITÀ**

Name und Adresse des Herstellers: / **STORZ MEDICAL AG**
Name and address of the manufacturer: / **Lohstampfestr. 8**
Nombre y dirección del fabricante: / **8274 Tägerwilen**
Nome e indirizzo del fabbricante: **SWITZERLAND**

Wir erklären in alleiniger Verantwortung, dass / We declare under our sole responsibility that /
Declaramos bajo nuestra única responsabilidad que / Dichiariamo sotto la sola responsabilità che

das Medizinprodukt: / **CHATTANOOGA Mobile 2 RPW USA** **Produktcode: CS**
the medical device: / **Product code: CS**
el producto sanitario: / **Código del producto: CS**
il dispositivo medico: **Codice prodotto: CS**

der Klasse: / **Ila**
of class: /
de la clase: /
di classe:

nach Anhang IX der Richtlinie 93/42/EWG / according to annex IX of directive 93/42/EEC /
conforme al anexo IX de la directiva 93/42/CEE / secondo l'allegato IX della direttiva 93/42/CEE

den einschlägigen Bestimmungen der Medizinprodukte-Richtlinie 93/42/EWG und deren Umsetzungen in nationale Gesetze entspricht. Die Erklärung gilt in Verbindung mit dem zum Produkt gehörigen Endabnahmeprotokoll.

meets the provisions of the directive 93/42/EEC and its transpositions in national laws which apply to it. The declaration is valid in connection with the final inspection report of the device.

cumple las disposiciones pertinentes de la Directiva de productos sanitarios 93/42/CEE y sus transposiciones a la legislación nacional. La presente declaración se aplicará junto con el protocolo de aceptación final que corresponda al producto.

soddisfa tutte le disposizioni della direttiva 93/42/CEE e della loro trasposizione nel diritto nazionale che lo riguardano. Questa dichiarazione è valida in congiunzione con il rapporto di ispezione finale del prodotto.

Konformitätsbewertungsverfahren: / **Richtlinie 93/42/EWG Anhang II, ohne Abschnitt 4**
Conformity assessment procedure: / **Directive 93/42/EEC Annex II, excluding Section 4**
Procedimiento para la evaluación de la conformidad: / **Directiva 93/42/CEE, anexo II, sin el apartado 4**
Procedura di valutazione della conformità: **Direttiva 93/42/CEE senza Allegato II, sezione 4**

Gültigkeitsdatum: / **31.12.2018**
Validity date: /
fecha de validez: /
data di validità: /

Benannte Stelle: /
Notified Body: /
Organismo notificado: /
Organismo notificato:



TÜV Rheinland LGA Products GmbH
Tillystraße 2
90431 Nürnberg
GERMANY
CE 0197

Dr. G. Heine, CEO

Tägerwilen, 23-05-2018

Ort, Datum / Place, date /

Lugar, fecha / Luogo, data

COC_GF_027_03_00 Version 1

Name und Funktion / Name and function /

Nombre y cargo / Nome e funzione

8. R-SW handpiece Specifications and Operation

8.1 INTRODUCTION



DANGER

Refers to a situation of acute danger which, if not avoided, could lead to serious or fatal injury.



WARNING

Refers to a situation of potential danger which, if not avoided, could lead to serious or fatal injury.



CAUTION

Refers to a situation of potential danger which, if not avoided, could lead to minor injury.

ATTENTION

Warns against possibly harmful situations that could lead to damage to either the product or to the surrounding area.

NOTE

Additional information concerning specific features or operating instructions is preceded by the term "NOTE".



CAUTION

Before using the R-SW handpiece for the first time, please ensure that you have read and understood all the information provided in this operating manual.

Familiarity with the information and instructions contained in this manual is essential for ensuring efficient and optimal use of the instrument, for avoiding hazards to personnel and equipment and for obtaining good treatment results.

Thorough knowledge of the information included in this manual will also enable you to react promptly and effectively in the event of malfunctions and errors.



HANDPIECE

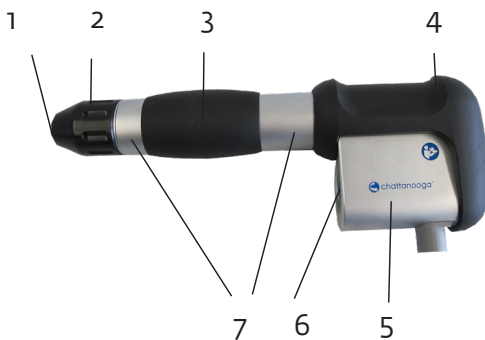

- 1 Shock transmitter
- 2 Shock transmitter screw cap
- 3 Shaft cushion
- 4 Handle cushion
- 5 Handpiece handle
- 6 Trigger button
- 7 Handpiece shaft

Handpiece with connecting cable



Example of a shock transmitter

NOTE

Pictures of handpiece and shock transmitters are examples. Individual components may differ from those shown in the illustration.

SHOCK TRANSMITTERS

Depending on the therapy to be performed, the handpiece can be equipped with different shock transmitters:

8.2 INSTALLING AND REPLACING THE TRANSMITTER

The handpiece is shipped fully assembled, but if the transmitter ever requires replacement, do the following:



CAUTION

Cleaning agents and disinfectants can form an explosive atmosphere.

- Disconnect the handpiece from the control device before starting any cleaning or maintenance work.



ATTENTION

It is essential that no fluid be permitted to penetrate either the instrument or its tubing.

Regular cleaning ensures perfect hygiene and operation of the R-SW handpiece. The handpiece, in particular the transmitter, must be thoroughly cleaned and disinfected after each therapy session.

8. R-SW handpiece Specifications and Operation

Component	Procedure	Interval
Handpiece shaft and cushion	clean and disinfect with usual alcohol-based cleaning agents and disinfectants	daily or after 20,000 shocks (whichever comes first)
Guide tube	clean from inside with brush	daily
Transmitters and o-rings	clean in ultrasound cleaning bath and disinfect	after each treatment or contact with a patient
Guide tube, projectile and o-rings	replace	after 1,000,000 shocks (handpiece overhaul)

Tab. 8-1 Cleaning intervals

NOTE

The handpiece is equipped with a projectile safety catch device in order to prevent the projectile from being ejected in case a shock is released while the shock transmitter and the shock transmitter screw cap are removed.

The safety catch is also activated if the shock transmitter screw cap is not screwed on tightly, if the sealing ring between the cap and the shock transmitter is missing or if two sealing rings (old and new) come together at the rear of the shock transmitter.



CAUTION

Danger of injury due to pulse triggering when handpiece is open.

- Disconnect the handpiece from the control unit before starting any cleaning or maintenance work.
- After the projectile safety catch device was released the first time this device **has to be** replaced. Please send the handpiece for reparation.

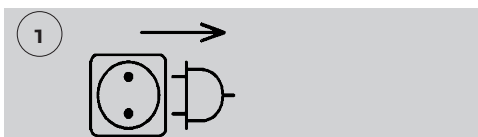
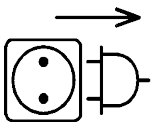

- Disconnect the handpiece from the control device.

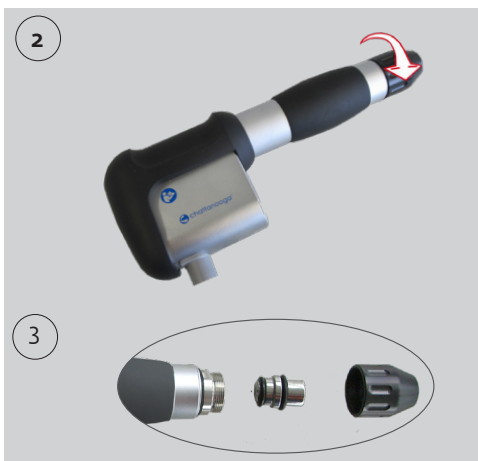

- Unscrew the transmitter screw cap from the handpiece.

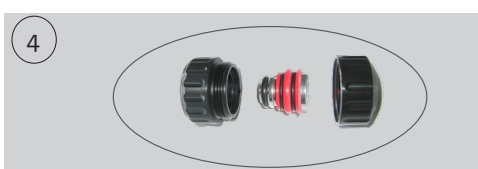

- Remove the transmitter insert.

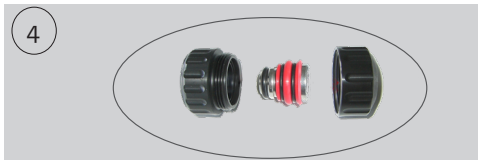

8. R-SW handpiece Specifications and Operation

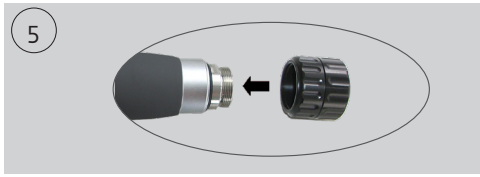

- Screw the transmitter screw cap onto the handpiece until finger-tight.



- After replacing the shock transmitter, make sure that the handpiece cap and the cap parts are screwed firmly in place.

NOTE
 Make sure that the two cap parts of the D20 and the D35 shock transmitters are screwed firmly in place and that the shock transmitter screw cap is screwed firmly to the shaft.
 Check the screw connection of the shock transmitter screw cap and cap parts during prolonged treatment phases

8.3 CLEANING OF THE HANDPIECE

NOTE
 After cleaning, the handpiece must be dry before it can be reassembled.

- For that reason, schedule sufficient time for the drying of the handpiece and its components.

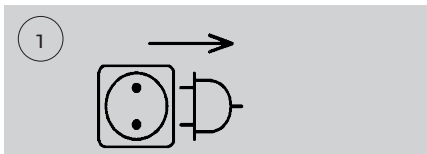

- Disconnect the handpiece from the control device.

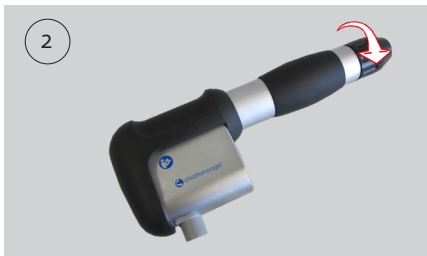

- Unscrew the transmitter screw cap from the handpiece.

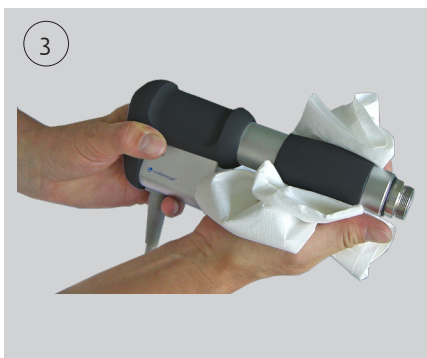

- Clean the coupling gel off the handpiece using a cleaning agent that is suitable for surface cleaning.
- Disinfect the handpiece with an alcohol-based disinfectant that is suitable for surface cleaning.

8. R-SW handpiece Specifications and Operation

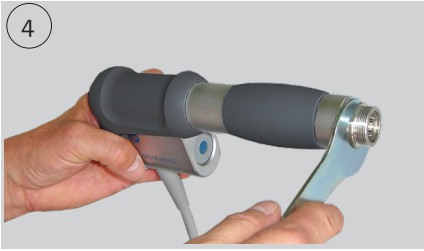

- Unscrew the shaft from the handpiece and pull it out of the handpiece handle (5).
- Use the supplied open-end spanner for this purpose (4).

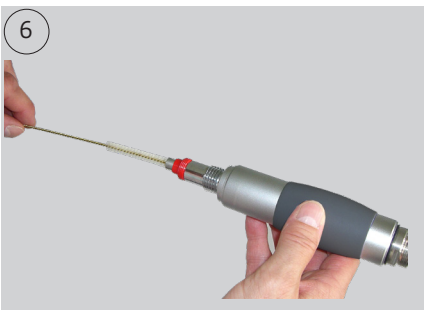

- Clean the guide tube with a brush in order to ensure perfect projectile movement.



- The protective cushion can be pulled back and up off the handpiece handle to clean the handpiece.



DANGER

If the unit is not safe for operation, it must be repaired by a certified service technician and the operators must be informed of the dangers posed by the unit.

8. R-SW handpiece Specifications and Operation

8.4 CLEANING THE TRANSMITTERS

- Unscrew the shock transmitter screw cap and remove the shock transmitter insert from the shock transmitter screw cap.

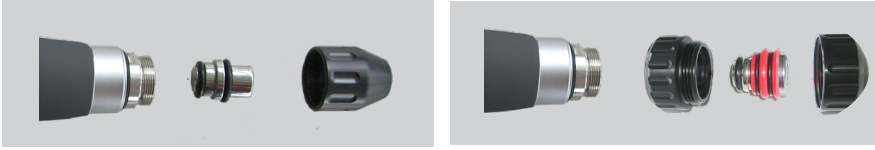

- Clean all of the parts under running water.

NOTE

The transmitter insert of the transmitters D20-S, D20-T and D35-S can only be dismantled and the sealing rings can only be removed using special tools. You should avoid doing this because it could result in damage to the transmitter. It is not necessary for cleaning purposes.

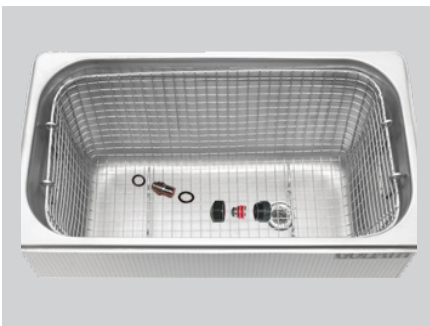

- We also recommend that the transmitters should be cleaned and disinfected in an ultrasonic bath.
- For this purpose, use only instrument disinfectants for heat-sensitive, reusable medical instruments.

8. R-SW handpiece Specifications and Operation

- Clean and disinfect the transmitter and the transmitter screw cap with the usual alcohol-based cleaning agents and disinfectants.
- Dry the transmitter and transmitter screw cap before screwing them together.
- Push the insert into the front cap and screw the two cap parts together until finger-tight.

NOTE

Make sure that the two cap parts of the D20 and the D35 shock transmitters are screwed firmly in place and that the shock transmitter screw cap is screwed firmly to the shaft.

- Check the screw connection of the shock transmitter screw cap and cap parts during prolonged treatment phases

8.5 R-SW HANDPIECE OVERHAUL

Shock waves are generated mechanically. Due to the effects of friction, the handpiece components are continuously exposed to mechanical stress which will cause minor wear.

NOTE

The R-SW handpiece should be overhauled about every 1,000,000 shocks. This can be done quickly and easily by the user of the instrument. All that is required is the overhaul kit that includes all required wearing parts.

8.5.1 CONTENTS OF THE R-SW OVERHAUL KIT

- 2 projectiles
- 2 guide tubes
- 2 socket sealing rings
- 1 O-ring guide

The overhaul kit is available from your dealer, part number 23825.

NOTE

The sealing rings, the projectile and the guide tube must always be replaced each time the handpiece is overhauled.

- Observe the O-ring Guide when selecting the sealing rings to be used. It is contained in the overhaul kit.



DANGER

If the unit is not safe for operation, it must be repaired by a certified service technician and the operators must be informed of the dangers posed by the unit.

8.5.2 OVERHAULING THE HANDPIECE

**CAUTION**

Danger of injury due to shock triggering when handpiece is open.

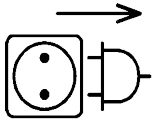

- Disconnect the handpiece from the control unit before replacing the transmitter

ATTENTION

An open-end spanner should be used to release the handpiece shaft when overhauling the handpiece.

- Place the handpiece on a dry, clean and dust-free surface.



- Disconnect the handpiece from the control device.
- Unscrew the transmitter screw cap from the handpiece.
- Unscrew the shaft from the handpiece and pull it out of the handpiece handle (5).
- Use the supplied open-end spanner for this purpose (5).
- Remove the tightly fitting guide tube from the shaft. If necessary, use a thin metal rod or the supplied hexagonal spanner as a pulling tool by inserting it through the openings in the guide tube.
- A corresponding fixture is provided in the handpiece handle to hold the projectile back. To remove the projectile, hold the handpiece handle with its opening pointing down. Gently knock the handle against the table surface until the projectile falls out. In the event that the projectile breaks apart due to overloading, a fragment of the projectile may be left behind inside the guide tube.

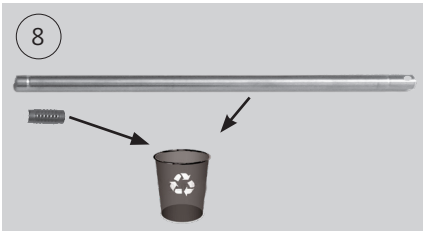

- Dispose of the used guide tube and the used projectile.

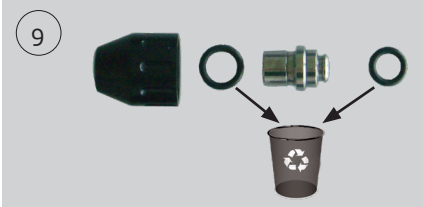

- Dispose of the detachable sealing rings of the shock transmitters and the sealing ring on the shaft.



- Clean the shaft, the transmitter (including firmly seated sealing rings) and the transmitter screw cap with an alcohol-based disinfectant. These are reused after cleaning.

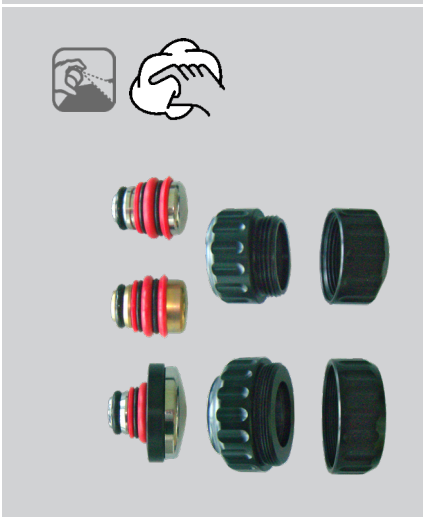

NOTE

The transmitter insert can only be dismantled and the sealing rings can only be removed using special tools. You should avoid doing this because it could result in damage to the transmitter. It is not necessary for cleaning purposes.



- Now take out of the overhaul kit the new sealing rings for the shock transmitters and for the shaft and install them. Observe the O-ring Guide for this purpose. It is contained in the overhaul kit.

- Take out the new guide tube and the new projectile from the overhaul kit.

- Insert the guide tube into the opening in the shaft by pressing it until it hits the stop.
- Make sure that the end of the guide tube where the two air slots are located is in the direction of the handpiece handle.

- Insert the new projectile into the fitted guide tube.

- Mount the new sealing ring from the overhaul kit onto the shaft.
- Screw the shaft into the handpiece until finger-tight.
- Hold the handpiece firmly on the table with one hand and tighten the shaft with the open-end spanner. It must no longer be possible to unscrew the shaft by hand.



- Screw the transmitter screw cap with the required transmitter tight back onto the shaft.
- Make sure that the two cap parts of the D20 and the D35 shock transmitters are screwed firmly in place and that the shock transmitter screw cap is screwed firmly to the shaft.

- Carry out a functional check of the handpiece (see **CHAPTER 3.3 FUNCTIONAL CHECKS**).
- Reset the handpiece shock counter on the control device (refer to **CHAPTER 3.7 RESETTING THE HANDPIECE SHOCK COUNTER**).

8.6 MAINTENANCE

Preventive maintenance is not necessarily required.

8.7 DISPOSAL



When disposing of this product, no special measures have to be observed. Please proceed in accordance with applicable country-specific regulations. After expiration of the service life of the handpiece, please return the instrument to DJO LLC.

8.8 REPAIR

Repair work on defective instruments must only be carried out by personnel suitably authorised by DJO LLC. Use only original parts designated by STORZ MEDICAL AG and supplied by DJO LLC. The personnel suitably authorised can be from DJO LLC or be representatives of DJO LLC agencies and dealers.

8.9 SERVICE LIFE

The R-SW handpiece should be overhauled about every 1 million shocks (see **CHAPTER 8.5 R-SW HANDPIECE OVERHAUL**). Provided this interval is observed, the average expected service life is approx. 5 million shocks for the handpiece and 1 million shocks for the transmitters.

Exceeding the service life can be expected to result in a failure of the instruments.

No warranty claims shall be accepted beyond the information given in **CHAPTER 10 WARRANTY AND SERVICE**.

For information about the service life of your control device, please refer to the **CHAPTER 4.7 SERVICE LIFE**.

8.10 TROUBLE -SHOOTING

Fault description	Possible cause	Corrective actions
No power output	Leaks in handpiece cable or cable not properly connected Blocked or worn projectile Handpiece defective No projectile Guide tube installed the wrong way round	Check the cable and tube connections and replace them, if necessary Dismantle the handpiece Overhaul the handpiece Replace the handpiece Install a projectile Turn the guide tube around
Irregular frequency	2 projectiles	Remove one projectile
Leak in the handpiece connector	Defective or missing red O-ring on plug	Send in handpiece or inform Service

8.11 ACCESSORIES AND SPARE PARTS

Handpiece overhaul kit	23825
Shaft cushion	22376
Handle cushion	22375

Shock transmitters

Detailed ordering information for the complete shock transmitter range is available from your local dealer. However, you can also contact the following address directly:

DJO, LLC
 1430 DECISION STREET
 VISTA, CA 92081
 USA
 T: +1 800 494 3395
 E: CHATTPRODUCTSUPPORT@DJOGLOBAL.COM

8. R-SW handpiece Specifications and Operation

8.12 APPLICATOR SPECIFICATIONS

R-SW Handpiece Technical Data	
Compressed Air Output	1.0 - 5 bar
Frequency	1.0 - 21 Hz

Ambient Air Temperature	
Ambient temperature during operation	10° C to 40° C (50° F to 104° F)
Ambient temperature during storage and transport	0° C to 60° C (32° F to 140° F), frost-free
Ambient air pressure during storage and transport	500 - 1060 hPa
Ambient air pressure during operation	800 - 1060 hPa
Air humidity during storage and transport	5 - 95% (non-condensing)
Air humidity during operation	Max. 55 %, non-condensing *in cases of local or seasonal elevated air humidity, we recommend the use of a commercially available air dehumidifier.
Weight	510 g (1.12 lb)
Protection Against Ingress of Water	IPX0

Subject to technical changes

This device complies with the applicable standards EN 60601-1, CAN CSA-C22.2 No. 601.1, UL Std. No 60601-1.

For the technical specifications of the control device, please refer to section 7.1 (TECHNICAL SPECIFICATIONS OF THE CONTROL DEVICE).

For information about conformity with directives, please refer to section 7.2 and following (TECHNICAL SPECIFICATIONS OF THE CONTROL DEVICE).

9. V-ACTOR II Specifications and Operation



CAUTION

Before you start using the V-ACTOR II for the first time, please make sure you have read and understood all information provided in this operating manual.



Familiarity with the information and instructions contained in this manual is essential for ensuring efficient and optimal use of the instrument, for avoiding hazards to personnel and equipment and for obtaining good treatment results.

Thorough knowledge of the information included in this manual will also enable you to react promptly and effectively in the event of malfunctions and errors.

When using optional accessories, please also refer to the separate operating manuals for each of these accessories. It is imperative that users be familiar with the content of this manual before operating any part of this system.

The V-ACTOR II is a “vibration therapy” handpiece and can be used as an optional accessory for radial pulse therapy and pressure pulses.

By using this handpiece, it is possible to treat soft tissues using high-frequency pulses.



Fig. 9 - 1 V-ACTOR II

- 1 Trigger button
- 2 Transmitter head

The prerequisites for using the V-ACTOR II handpiece correspond to the prerequisites for operating your control device. Please read the Prerequisites for Operating **chapter 1.3**.

9. V-ACTOR II Specifications and Operation

Depending on the therapy to be performed, the handpiece can be equipped with one of the following two transmitter heads:

- with the V-ACTOR transmitter 25 mm (V25)
- with the V-ACTOR transmitter 40 mm (V40)

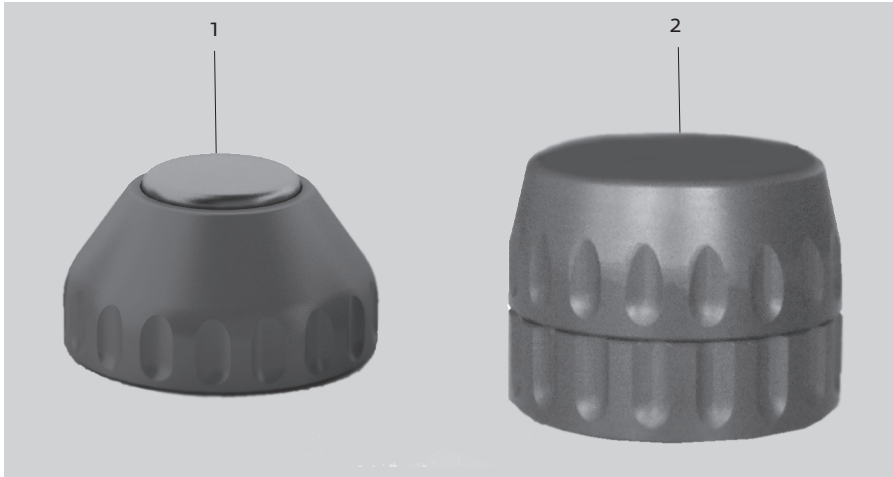

Fig. 9 - 2 V-ACTOR transmitters

- 1 V25
- 2 V40

9.1 SCOPE OF SUPPLY

- V-ACTOR II handpiece with 2 transmitters. The V-ACTOR transmitters V25 and V40 are supplied with a transmitter screw cap.

9.2 UNPACKING

- Carefully remove the handpiece from the packaging.
- Check that all items are included in the packaging container and that they are not damaged.
- Contact your supplier or the manufacturer immediately if any items are missing or damaged.

9.3 CONNECTING THE HANDPIECE

NOTE

Please also refer to chapter 3 for operation of your control device.

- Connect the plug of the V-ACTOR II handpiece to the R-SW connector on the respective control device.
- Line up the red dots on the plug with the red dots on the connector before connecting.

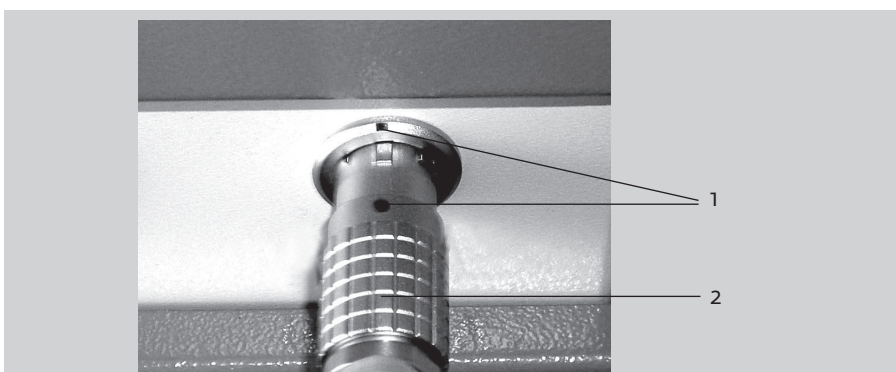

Fig. 9 - 3 Connecting the handpiece

9. V-ACTOR II Specifications and Operation

- Gently pushing the plug into the connector will immediately lock the connection and will prevent the connector from disengaging automatically when the cable is pulled.
- To break the connection, pull the outside of the plug body. This means the locking function is initially released, then the plug is pulled out of the socket.

9.4 REPLACING THE TRANSMITTER

- V25
- To remove the 25 mm transmitter, unscrew the transmitter screw cap from the handpiece and pull the transmitter out.
- Clean all parts of the transmitter as described in **CHAPTER 9.11 CLEANING**.
- Reassemble the transmitter in reverse order.
- Screw the new transmitter onto the handpiece until finger-tight.

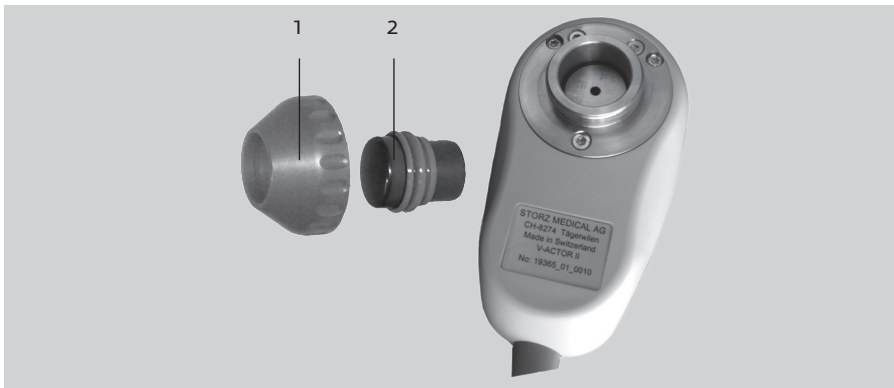

Fig. 9 - 4 Replacing the transmitter V25

- V40
- To remove the transmitter V40, unscrew the transmitter from the handpiece.
- Unscrew the transmitter screw cap and pull the transmitter out.
- Remove the sealing ring by pressing it apart at the cut-through point.
- To clean, press the spring element together slightly and remove the residues underneath it.
- Clean all parts of the transmitter as described in **CHAPTER 9.11 CLEANING**.
- Reassemble the transmitter in reverse order.
- Make sure that the smooth side of the sealing ring is in contact with the transmitter head.
- Screw the new transmitter onto the handpiece until finger-tight.

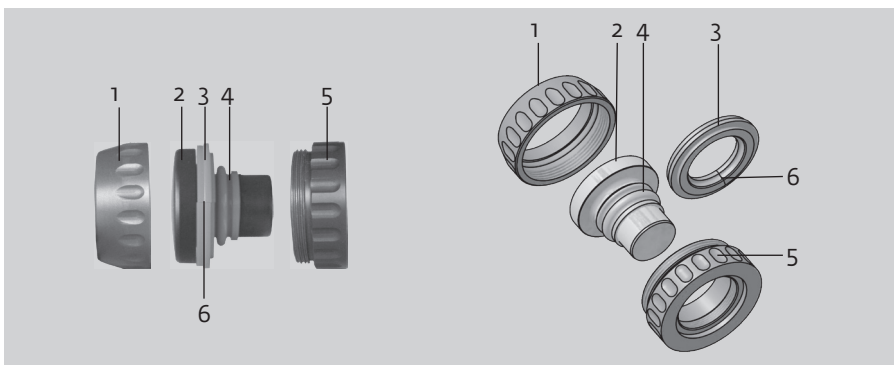

Fig. 9 - 5 Transmitter V40

- 1 Front cap
- 2 Transmitter head
- 3 Sealing ring
- 4 Spring element
- 5 Rear cap
- 6 Cut-through point

9. V-ACTOR II Specifications and Operation

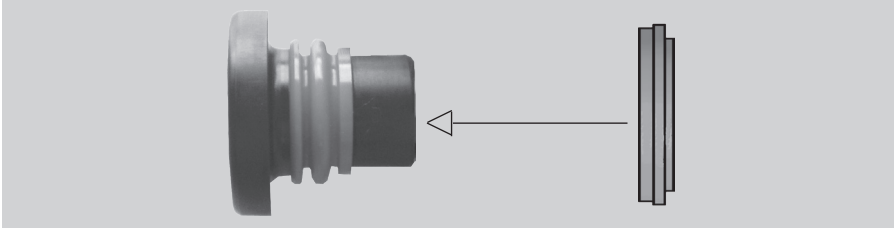

Fig. 9 - 6 Mount the sealing ring

9.5 GENERAL WARNINGS AND SAFETY INFORMATION



CAUTION

The V-ACTOR II handpiece is intended exclusively for use by medical specialists and must only be used by suitably qualified and trained medical personnel.

The user is responsible for correctly positioning the handpiece.

Correct determination of the location of the treatment zone is the responsibility of the user.

Only perform treatments approved by STORZ MEDICAL AG!

Risk of transmission of microorganisms! Clean the handpiece after each use! Refer to **CHAPTER 9.11 CLEANING** for details.

9.6 SETTING THE V-ACTOR II TREATMENT PARAMETERS

The V-ACTOR operating mode is called up automatically on the control device display when the V-ACTOR II handpiece is connected.

NOTE

Refer to chapter 3 OPERATION to see the structure of the display and menu navigation.

The pulse frequency in V-ACTOR mode can be selected in steps up to 31 Hz at 1.4 to 5.0 bar.

9. V-ACTOR II Specifications and Operation

9.7 START-UP

- Connect the V-ACTOR II handpiece to the control device.
- Set the energy in V-ACTOR operating mode to an initial value of 2 bar.
- Activate the V-ACTOR II trigger button.

NOTE

The trigger button functions as an on/off switch when it is pressed briefly. Pressing it for longer causes it to function as a tip switch, i.e. the pulses will continue until the button is released.

9.8 FUNCTIONAL CHECKS

- Set the energy level in V-ACTOR mode to 2.4 bar.
- Reset the actual number of pulses on the parameter display of the control panel.
- Release pulses with a frequency of 31 Hz.
- Check that the triggered pulses are correctly counted on the treatment pulse counter of the control device.

9.9 STANDARD SETTINGS

- Start the V-ACTOR II treatment at an energy level of 2 bar and a frequency of 20 Hz.
- For more detailed instructions, refer to the application brochure and the treatment recommendations.

9.10 TREATMENT



CAUTION

Read **CHAPTER 3.1 GENERAL WARNINGS AND SAFETY INFORMATION** before beginning treatment.

NOTE

The maximum energy level used during treatment must not cause the patient undue pain under any circumstances.

- Apply a sufficient amount of massage oil to the patient's skin in the treatment area and to the V-ACTOR II transmitter.
- Perform the V-ACTOR II treatment as recommended in the application brochure / treatment recommendations.



CAUTION

The handpiece may not be operated while idling (without an impact surface).

- Do not trigger pulses unless the pulse transmitter is in contact with the treatment zone!



CAUTION

We recommend that the user and the patient wear suitable hearing protection.

- Always offer the patient hearing protection.



9. V-ACTOR II Specifications and Operation

9.11 CLEANING



CAUTION

Cleaning agents and disinfectants can form an explosive atmosphere. Disconnect the handpiece and the control device from the mains before starting any cleaning or maintenance work.

ATTENTION

Make absolutely sure that no liquid can seep into the handpiece.

The handpiece must be thoroughly cleaned and disinfected after each therapy session.

- Clean the remaining massage oil off the handpiece using a damp cloth.
- Disinfect the handpiece with a surface disinfectant.
- Clean the shock transmitters thoroughly after each use. Unscrew the shock transmitter screw cap and remove the shock transmitter insert if necessary.
- The shock transmitters can be cleaned using the usual cleaning agents and disinfectants.
- Clean the shock transmitters each day in an ultrasonic bath.
- Proceed as follows to clean the shock transmitters:

V40 shock transmitter:

- Unscrew the shock transmitter from the handpiece, disassemble the threaded two-part shock transmitter screw cap, remove the shock transmitter insert from the front cap and take out the front sealing ring. This is cut open so that it can be removed more readily. The spring element on the shock transmitter insert does not need to be removed.
- Clean all of the parts under running water.
- Clean and disinfect the shock transmitter insert and the sealing ring in an ultrasonic bath.
- For this purpose, use only instrument disinfectants for heat-sensitive, reusable medical devices.

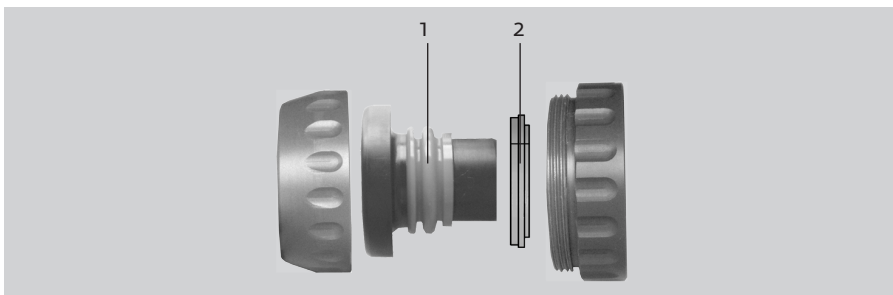

Fig. 9 - 7 V40 shock transmitter disassembled

- 1 Spring element
- 2 Front sealing ring

9. V-ACTOR II Specifications and Operation

V25 shock transmitter:

- Unscrew the shock transmitter from the handpiece and remove the shock transmitter insert from the front cap. The spring element on the shock transmitter insert does not need to be removed.
- Clean all of the parts under running water.
- Clean and disinfect the shock transmitter insert and the sealing ring in an ultrasonic bath.
- For this purpose, use only instrument disinfectants for heat-sensitive, reusable medical devices.

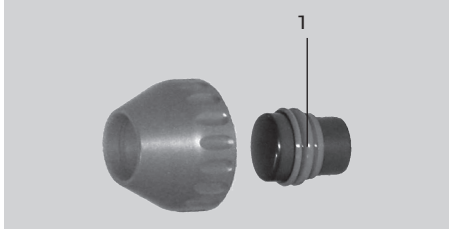

Fig. 9 - 8 V25 shock transmitter

1 Spring element



Fig. 9 - 9 Fig Ultrasonic bath with V-ACTOR shock transmitters

9.12 DISPOSAL



No special precautions need be taken when disposing of the V-ACTOR II handpiece. Please proceed in accordance with applicable country-specific regulations. The instrument must be disposed of as waste electronic equipment at the end of its service life.

9.13 REPAIR

Repair work on defective instruments must only be carried out by personnel suitably authorised by DJO LLC. Use only original parts designated by STORZ MEDICAL AG and supplied by DJO LLC. The personnel suitably authorised can be from DJO LLC or be representatives of DJO LLC agencies and dealers.

9.14 SERVICE LIFE

The average expected service life of the handpiece is approx. 5 million pulses.

Exceeding the service life can be expected to result in a failure of the instruments.

No warranty claims shall be accepted beyond the information given in **CHAPTER 10 WARRANTY**.

For information about the service life of your control device, please refer to **CHAPTER 4.7 SERVICE LIFE**.

9. V-ACTOR II Specifications and Operation

9.15 TROUBLE-SHOOTING

Fault description	Possible cause	Corrective action
No compressed air supply	Leaks in handpiece cable, or cable not properly connected	Check the cable and tube connections and replace them, if necessary.
No power output	Handpiece defective	Replace the handpiece.



CAUTION

Disconnect the handpiece from the control device before starting any maintenance work!

9.16. ACCESSORIES AND SPARE PARTS

V-ACTOR II handpiece set	28730
25 mm transmitter	28740
40 mm transmitter	28741

9. V-ACTOR II Specifications and Operation

9.17 TECHNICAL SPECIFICATIONS

V-ACTOR II operating frequency	1.0 - 31 Hz
Energy selection	in steps from 1.4 to 5 bar
Ambient temperature during operation	10° - 40°C
Ambient temperature during storage and transport	0° - 60°C frost-free
Ambient air pressure during storage and transport	500 - 1060 hPa
Ambient air pressure during operation	800 - 1060 hPa
Air humidity	5 - 95%, non-condensing
Weight	370g
Protection against the ingress of water	IPX0

Subject to technical modifications

NOTE

When the medical product is distributed to third parties, the following must be observed:

- The complete device documentation must be delivered together with the medical product.
- The medical product may only be exported to a foreign country when the medical product and the corresponding indications are allowed there.

10. Warranty and Service

ATTENTION

Modifications to the instrument or handpiece are not permitted. Any unauthorised opening, repair or modification by unauthorised personnel will relieve the manufacturer of its liability and responsibility for safe system operation. This will automatically void the warranty even before the end of the warranty period.

10.1 WARRANTY

DJO LLC, ("Company") warrants that the Mobile 2 RPW USA ("Product") is free of defects in material and workmanship. This warranty shall remain in effect for two years from the date of original consumer purchase. If this Product fails to function during the two year warranty period due to a defect in material or workmanship, at the Company's Option, Company or the selling dealer will repair or replace this Product without charge.

All repairs to the Product must be performed by a service center certified by the Company. Any modifications or repairs performed by unauthorized centers or groups will void this warranty.

- The warranty for the handpiece is two years or three million shocks, whatever occurs first.
- The warranty for the shock transmitters is one year or one million shocks, whatever occurs first.
- The consumables are not covered by the handpiece's warranty.

This Warranty Does Not Cover:

- Replacement parts or labor furnished by anyone other than the Company, the selling dealer or a certified Company service technician.
- Defects or damage caused by labor furnished by someone other than Company, the selling dealer or a certified Company service technician.
- Any malfunction or failure in the Product caused by product misuse, including, but not limited to, the failure to provide reasonable and necessary maintenance or any use that is inconsistent with the Product User's Manual.
- DJO LLC is not responsible for injury or damage resulting from modifications or service performed by non-authorized DJO LLC service personnel.

COMPANY SHALL NOT BE LIABLE IN ANY EVENT FOR INCIDENTAL OR CONSEQUENTIAL DAMAGES.

Some areas do not allow the exclusion or limitation of incidental or consequential damages, so the above limitation or exclusion may not apply to you.

To obtain service from Company or the selling dealer under this warranty:

1. A written claim must be made within the warranty period to the Company or the selling dealer.
2. The Product must be returned to the Company or the selling dealer by the owner.

This warranty gives you specific legal rights and you may also have other rights which vary from region to region.

The Company does not authorize any person or representative to create for it any other obligation or liability in connection with the sale of the Product. Any representation or agreement not contained in the warranty shall be void and of no effect.

THE FOREGOING WARRANTY IS IN LIEU OF ALL OTHER WARRANTIES, EXPRESSED OR IMPLIED, INCLUDING ANY WARRANTY OR MERCHANTABILITY OR FITNESS FOR A PARTICULAR PURPOSE.

10. Warranty and Service

10.2 WARRANTY FOR THE HANDPIECE

Warranty claims will only be accepted if the handpiece is returned in its complete and original state, cleaned and in the case, with the repair label filled in completely.

Missing components will be replaced subject to charge. Accessories also sent will be checked and, if necessary, replaced after we have assessed them.

Shock transmitters and overhaul kits are not covered by the handpiece's warranty.

10.3 SERVICE

Should you have any further questions or require additional information, please feel free to contact your dealer

DJO, LLC
1430 DECISION STREET
VISTA, CA 92081
USA
T: +1 800 494 3395
E: CHATTPRODUCTSUPPORT@DJOGLOBAL.COM



STORZ MEDICAL AG
Lohstampfstrasse 8
CH-8274, Tägerwil
Switzerland

⁺
MOTION IS MEDICINE[®]